

SPEERS S

By David Abad



Description:

Suspension lamp system available with different sizes of shade. The S shade is made in copper or brass and available in solid copper or brass finishes, both with a shiny exterior and a satin interior. It is also sold in a textured matte black or white exterior, combined with a shade interior in satin brass or copper. M and L shades are made in aluminium and available in solid textured white or matte black. The Speers single fixture lamps are available in a surface version (S1) or in a recessed version (SR1). The multiple fixture lamps (S2, S3, S4, S5 and S6) are only sold in a surface version and the flat canopies are always white or black. Speers lamps are equipped with a high-luminance LED light source. They include a glass lens that focuses the light and enhances its luminous efficiency. There is an optional opal diffuser providing general diffused lighting.

SPEERS S1

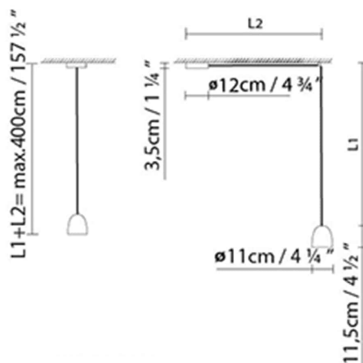

SPEERS SR1

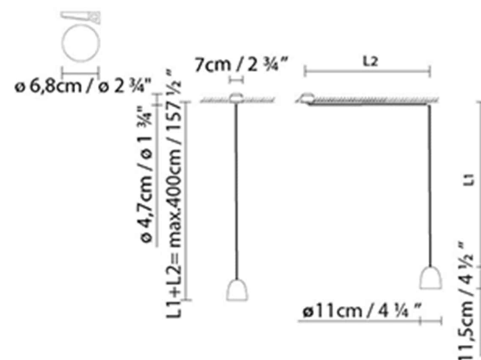

SPEERS S2

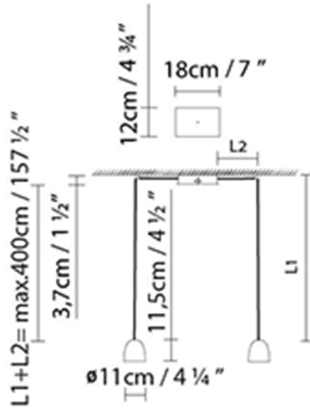

SPEERS S3

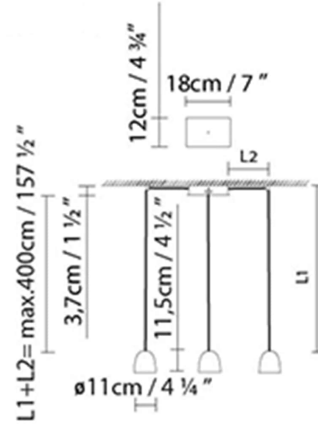

SPEERS S4

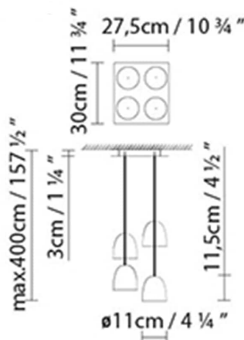

SPEERS S6

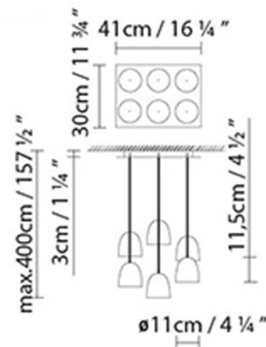

Copper (shiny) / copper (satin)



White (matte) / copper (satin)



Black (matte) / copper (satin)



Brass (shiny) / brass (satin)



White (matte) / brass (satin)



Black (matte) / brass (satin)

CODE	LAMP	LIGHT SOURCE	DIM	BULB	BULB WEIGHT	LED
729300	SPEERS S1 COPPER-COPPER					
729305	SPEERS S1 BRASS-BRASS					
729302	SPEERS S1 BLACK-COPPER	LED 9W 1100lm 500mA 2700K CRI≥90 110-230V DIM	PHASE CUT	A++	1,75	LED A+
729307	SPEERS S1 BLACK-BRASS					
729301	SPEERS S1 WHITE-COPPER					
729306	SPEERS S1 WHITE-BRASS					
729310	SPEERS SR1 COPPER-COPPER					
729315	SPEERS SR1 BRASS-BRASS					
729312	SPEERS SR1 BLACK-COPPER	LED 9W 1100lm 500mA 2700K CRI≥90 230V		A++	1,75	LED A+
729317	SPEERS SR1 BLACK-BRASS					
729311	SPEERS SR1 WHITE-COPPER					
729316	SPEERS SR1 WHITE-BRASS					

729390	SPEERS SINGLE COPPER+			
729395	SPEERS SINGLE BRASS+			
729392	SPEERS SINGLE BLACK-COPPER+	LED 9W 1100lm 500mA 2700K CRI≥90	A++	
729397	SPEERS SINGLE BLACK-BRASS+			
729391	SPEERS SINGLE WHITE-COPPER+			
729396	SPEERS SINGLE WHITE-BRASS+			
<hr/>				
729362	SPEERS S2/3 CANOPY BLACK+			PUSH-DALI
729361	SPEERS S2/3 CANOPY WHITE+			
729372	SPEERS S4 CANOPY BLACK+			PUSH-1-10V
729371	SPEERS S4 CANOPY WHITE+			
729382	SPEERS S6 CANOPY BLACK+			PUSH-1-10V
729381	SPEERS S6 CANOPY WHITE+			



SPEERS S



SPEERS F



SPEERS W

ERC

Collection:

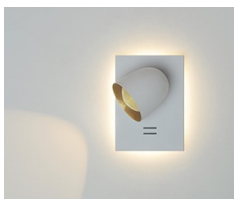

Designer

Fotometría

Technical drawing

Instrucciones de montaje

3D

grupoblux.com